

Building Bayes Networks: Structure Learning

Evaluation Measures and Search Methods

All learning algorithms for graphical models consist of an **evaluation measure** or **scoring function** and a (heuristic) **search method**, e. g.

- conditional independence search
- greedy search (spanning tree or K2 algorithm)
- guided random search (simulated annealing, genetic algorithms)

An exhaustive search over all graphs is too expensive:

- $2^{\binom{n}{2}}$ possible undirected graphs for n attributes.
- $f(n) = \sum_{i=1}^n (-1)^{i+1} \binom{n}{i} 2^{i(n-i)} f(n-i)$ possible directed acyclic graphs.

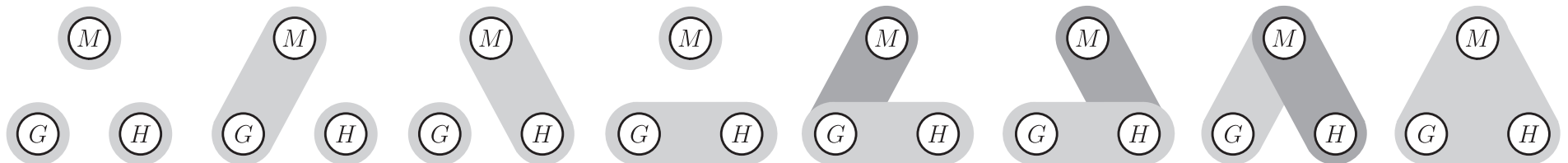

8 possible undirected graphs with 3 nodes

Relational Networks

Hartley Information Gain

Conditional Hartley Information Gain

Probabilistic Networks

χ^2 -Measure

Mutual Information / Cross Entropy / Information Gain

(Symmetric) Information Gain Ratio

(Symmetric/Modified) Gini Index

Bayesian Measures (K2 metric, BDeu metric)

Measures based on the Minimum Description Length Principle

Other measures that are known from Decision Tree Induction

Learning the Structure of Graphical Models from Data

(A) Test whether a distribution is decomposable w. r. t. a given graph.

This is the most direct approach. It is not bound to a graphical representation, but can also be carried out w.r.t. other representations of the set of subspaces to be used to compute the (candidate) decomposition of the given distribution.

(B) Find a suitable graph by measuring the strength of dependences.

This is a heuristic, but often highly successful approach, which is based on the frequently valid assumption that in a conditional independence graph an attribute is more strongly dependent on adjacent attributes than on attributes that are not directly connected to them.

(C) Find an independence map by conditional independence tests.

This approach exploits the theorems that connect conditional independence graphs and graphs that represent decompositions. It has the advantage that a single conditional independence test, if it fails, can exclude several candidate graphs. However, wrong test results can thus have severe consequences.

Testing for Decomposability: Comparing Relations

In order to evaluate a graph structure, we need a measure that compares the actual relation to the relation represented by the graph.

For arbitrary R , E_1 , and E_2 it is

$$R(E_1 \cap E_2) \leq \min\{R(E_1), R(E_2)\}.$$

This relation entails that for any family \mathcal{M} of subsets of U it is always:

$$\forall a_1 \in \text{dom}(A_1) : \dots \forall a_n \in \text{dom}(A_n) : \\ r_U \left(\bigwedge_{A_i \in U} A_i = a_i \right) \leq \min_{M \in \mathcal{M}} \left\{ r_M \left(\bigwedge_{A_i \in M} A_i = a_i \right) \right\}.$$

Therefore: Measure the quality of a family \mathcal{M} as:

$$\sum_{a_1 \in \text{dom}(A_1)} \dots \sum_{a_n \in \text{dom}(A_n)} \left(\min_{M \in \mathcal{M}} \left\{ r_M \left(\bigwedge_{A_i \in M} A_i = a_i \right) \right\} - r_U \left(\bigwedge_{A_i \in U} A_i = a_i \right) \right)$$

Intuitively: **Count the number of additional tuples.**

Direct Test for Decomposability: Relational

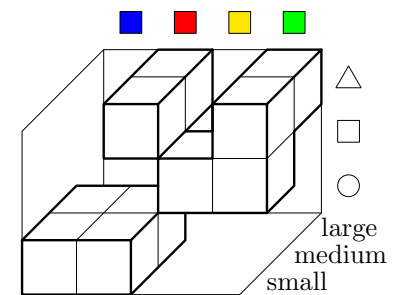
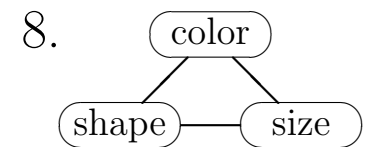
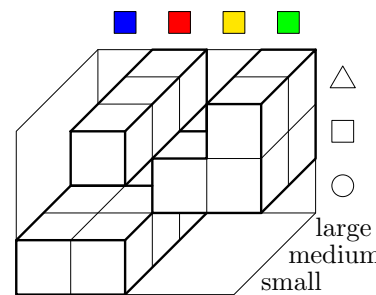
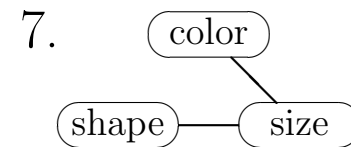
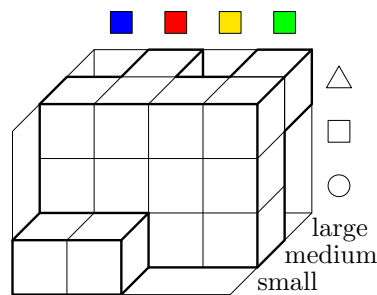
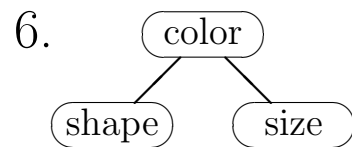
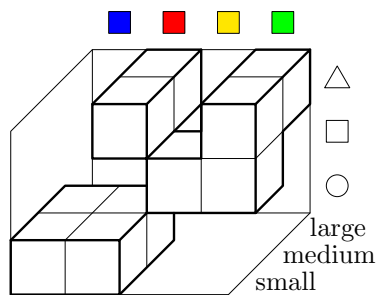
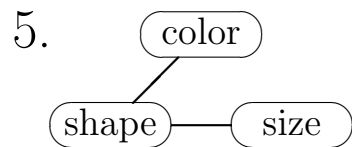
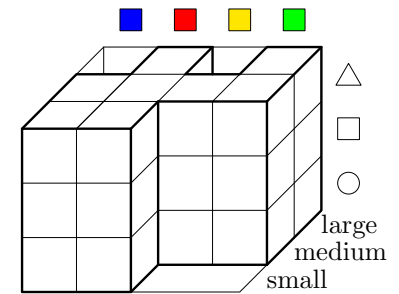
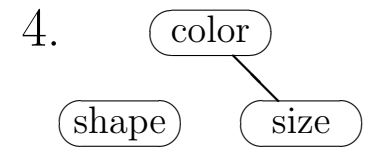
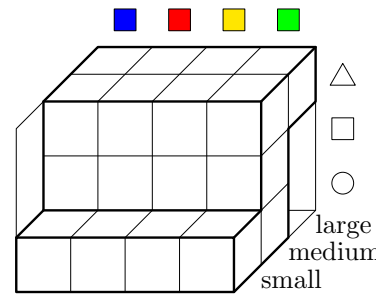
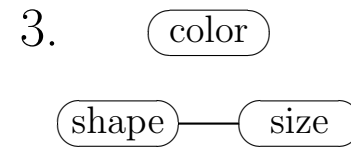
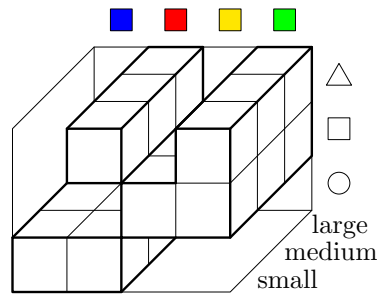
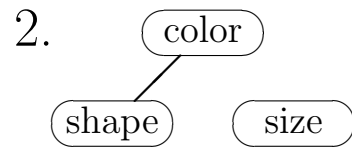
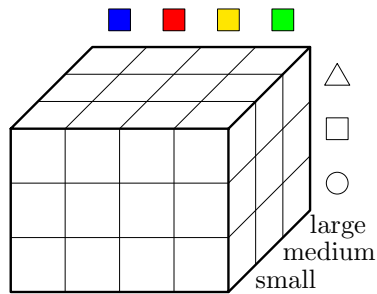
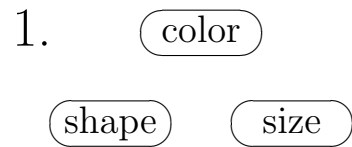

Comparing Probability Distributions

Definition: Let P_1 and P_2 be two strictly positive probability distributions on the same set \mathcal{E} of events. Then

$$I_{\text{KLdiv}}(P_1, P_2) = \sum_{F \in \mathcal{E}} P_1(F) \log_2 \frac{P_1(F)}{P_2(F)}$$

is called the **Kullback-Leibler information divergence** of P_1 and P_2 .

The Kullback-Leibler information divergence is non-negative.

It is zero if and only if $P_1 \equiv P_2$.

Therefore it is plausible that this measure can be used to assess the quality of the approximation of a given multi-dimensional distribution P_1 by the distribution P_2 that is represented by a given graph:

The smaller the value of this measure, the better the approximation.

Direct Test for Decomposability: Probabilistic

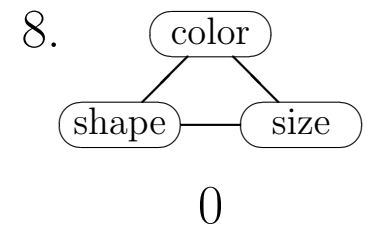
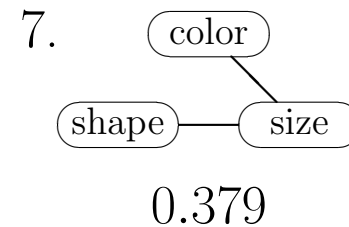
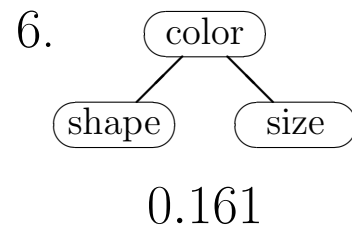
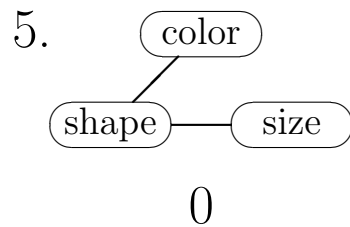
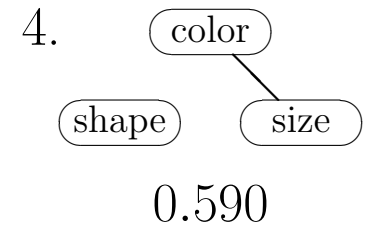
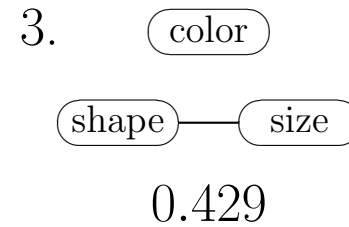
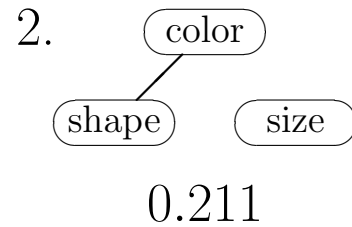
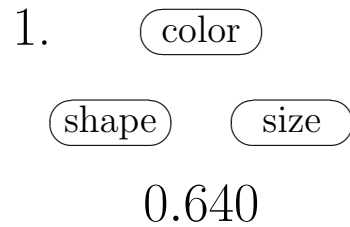

Numbers below graphs: The Kullback-Leibler information divergence of the original distribution and its approximation.

Excursus: Shannon Entropy

Let X be a random variable with domain $\text{dom}(X) = \{x_1, \dots, x_n\}$. Then,

$$H^{(\text{Shannon})}(X) = - \sum_{i=1}^n P(x_i) \log_2 P(x_i)$$

is called the **Shannon entropy** of (the probability distribution of) X , where $0 \cdot \log_2 0 = 0$ is assumed.

Intuitively: **Expected number of yes/no questions that have to be asked in order to determine the obtaining value of X .**

- Suppose there is an oracle, which knows the obtaining value, but responds only if the question can be answered with “yes” or “no”.
- A better question scheme than asking for one alternative after the other can easily be found: Divide the set into two subsets of about equal size.
- Ask for containment in an arbitrarily chosen subset.
- Apply this scheme recursively \rightarrow number of questions bounded by $\lceil \log_2 n \rceil$.

Question/Coding Schemes

$$P(x_1) = 0.10, \quad P(x_2) = 0.15, \quad P(x_3) = 0.16, \quad P(x_4) = 0.19, \quad P(x_5) = 0.40$$

$$\text{Shannon entropy: } -\sum_i P(x_i) \log_2 P(x_i) = 2.15 \text{ bit/symbol}$$

Linear Traversal

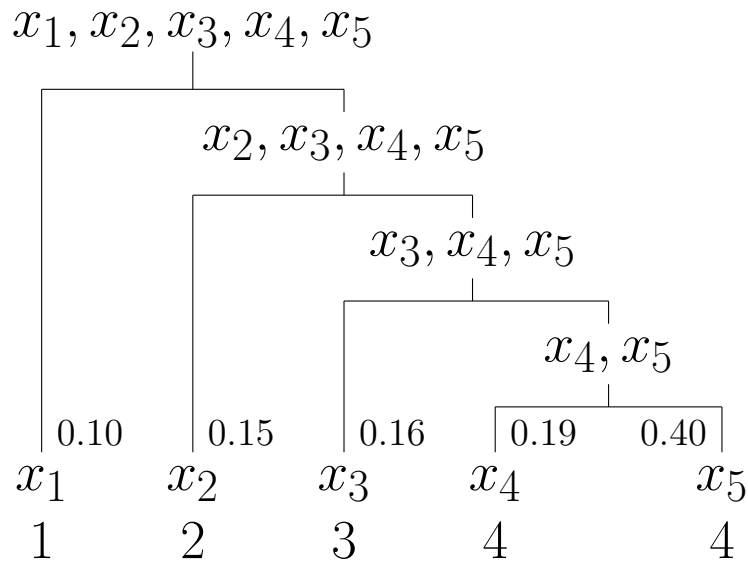

Code length: 3.24 bit/symbol

Code efficiency: 0.664

Equal Size Subsets

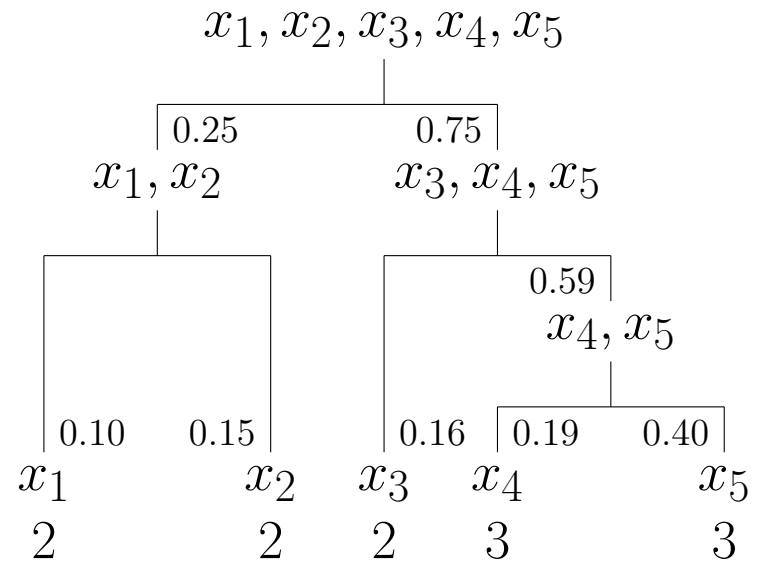

Code length: 2.59 bit/symbol

Code efficiency: 0.830

Question/Coding Schemes

Splitting into subsets of about equal size can lead to a bad arrangement of the alternatives into subsets → high expected number of questions.

Good question schemes take the probability of the alternatives into account.

Shannon-Fano Coding (1948)

- Build the question/coding scheme top-down.
- Sort the alternatives w.r.t. their probabilities.
- Split the set so that the subsets have about equal *probability* (splits must respect the probability order of the alternatives).

Huffman Coding (1952)

- Build the question/coding scheme bottom-up.
- Start with one element sets.
- Always combine those two sets that have the smallest probabilities.

Question/Coding Schemes

$$P(x_1) = 0.10, \quad P(x_2) = 0.15, \quad P(x_3) = 0.16, \quad P(x_4) = 0.19, \quad P(x_5) = 0.40$$

$$\text{Shannon entropy: } -\sum_i P(x_i) \log_2 P(x_i) = 2.15 \text{ bit/symbol}$$

Shannon–Fano Coding (1948)

Huffman Coding (1952)

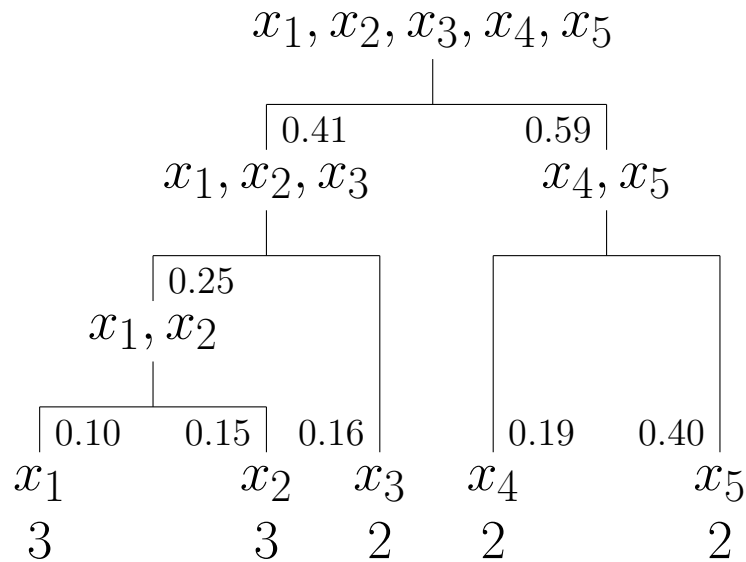

Code length: 2.25 bit/symbol

Code efficiency: 0.955

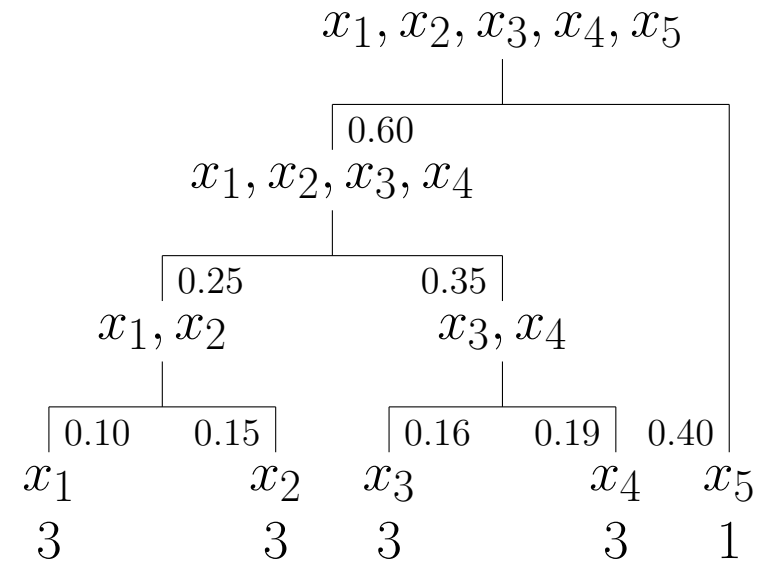

Code length: 2.20 bit/symbol

Code efficiency: 0.977

Question/Coding Schemes

It can be shown that Huffman coding is optimal if we have to determine the obtaining alternative in a single instance.

(No question/coding scheme has a smaller expected number of questions.)

Only if the obtaining alternative has to be determined in a sequence of (independent) situations, this scheme can be improved upon.

Idea: Process the sequence not instance by instance, but combine two, three or more consecutive instances and ask directly for the obtaining combination of alternatives.

Although this enlarges the question/coding scheme, the expected number of questions per identification is reduced (because each interrogation identifies the obtaining alternative for several situations).

However, the expected number of questions per identification cannot be made arbitrarily small. Shannon showed that there is a lower bound, namely the Shannon entropy.

Interpretation of Shannon Entropy

$$P(x_1) = \frac{1}{2}, \quad P(x_2) = \frac{1}{4}, \quad P(x_3) = \frac{1}{8}, \quad P(x_4) = \frac{1}{16}, \quad P(x_5) = \frac{1}{16}$$

Shannon entropy: $-\sum_i P(x_i) \log_2 P(x_i) = 1.875$ bit/symbol

If the probability distribution allows for a perfect Huffman code (code efficiency 1), the Shannon entropy can easily be interpreted as follows:

$$-\sum_i P(x_i) \log_2 P(x_i)$$
$$= \sum_i \underbrace{P(x_i)}_{\text{occurrence probability}} \cdot \underbrace{\log_2 \frac{1}{P(x_i)}}_{\text{path length in tree}}.$$

In other words, it is the expected number of needed yes/no questions.

Perfect Question Scheme

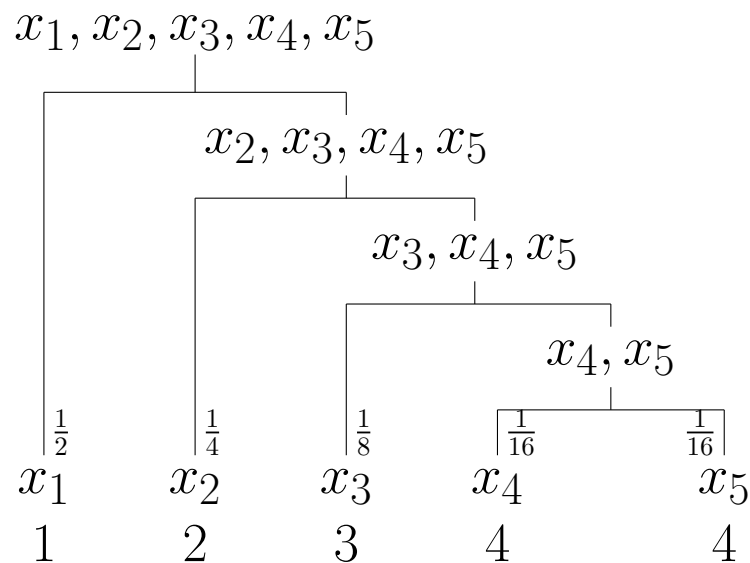

Code length: 1.875 bit/symbol

Code efficiency: 1

Information Content

The information content of an event $F \in \mathcal{E}$ that occurs with probability $P(F)$ is defined as

$$\text{Inf}_P(F) = -\log_2 P(F).$$

Intention:

Neglect all subjective references to F and let the information content be determined by $P(F)$ only.

The information of a certain message ($P(\Omega) = 1$) is zero.

The less frequent a message occurs (i. e., the less probable it is), the more interesting is the fact of its occurrence:

$$P(F_1) < P(F_2) \quad \Rightarrow \quad \text{Inf}_P(F_1) > \text{Inf}_P(F_2)$$

We only use one bit to encode the occurrence of a message with probability $\frac{1}{2}$.

Excursus: Information Content

The function Inf fulfills all these requirements:

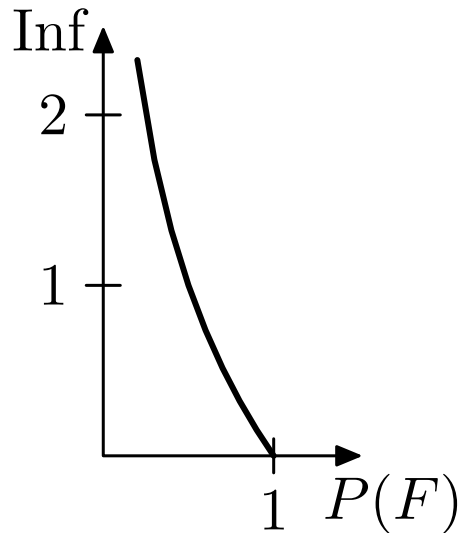

The expected value (w. r. t. to a probability distribution P_1) of Inf_{P_2} can be written as follows:

$$E_{P_1}(\text{Inf}_{P_2}) = - \sum_{F \in \mathcal{E}} P_1(F) \cdot \log_2 P_2(F)$$

$H^{(\text{Shannon})}(P)$ is the expected value (in bits) of the information content that is related to the occurrence of the events $F \in \mathcal{E}$:

$$H(P) = E_P(\text{Inf}_P)$$

$$H^{(\text{Shannon})}(P) = \sum_{F \in \mathcal{E}} \underbrace{P(F)}_{\text{Probability of } F} \cdot \underbrace{(-\log_2 P(F))}_{\text{Information content of } F}$$

Excursus: Approximation Measure

Let P^* be a hypothetical probability distribution and P a (given or known) probability distribution that acts as a reference.

We can compare both P^* and P by computing the **difference of the expected information contents**:

$$\begin{aligned} E_P(\text{Inf}_{P^*}) - E_P(\text{Inf}_P) &= - \sum_{F \in \mathcal{E}} P(F) \log_2 P^*(F) + \sum_{F \in \mathcal{E}} P(F) \log_2 P(F) \\ &= \sum_{F \in \mathcal{E}} \left(P(F) \log_2 P(F) - P(F) \log_2 P^*(F) \right) \\ &= \sum_{F \in \mathcal{E}} P(F) \left(\log_2 P(F) - \log_2 P^*(F) \right) \\ I_{\text{KLdiv}}(P, P^*) &= \sum_{F \in \mathcal{E}} P(F) \log_2 \frac{P(F)}{P^*(F)} \end{aligned}$$

Learning the Structure of Graphical Models from Data

(A) Test whether a distribution is decomposable w.r.t. a given graph.

This is the most direct approach. It is not bound to a graphical representation, but can also be carried out w.r.t. other representations of the set of subspaces to be used to compute the (candidate) decomposition of the given distribution.

(B) Find a suitable graph by measuring the strength of dependences.

This is a heuristic, but often highly successful approach, which is based on the frequently valid assumption that in a conditional independence graph an attribute is more strongly dependent on adjacent attributes than on attributes that are not directly connected to them.

(C) Find an independence map by conditional independence tests.

This approach exploits the theorems that connect conditional independence graphs and graphs that represent decompositions. It has the advantage that a single conditional independence test, if it fails, can exclude several candidate graphs. However, wrong test results can thus have severe consequences.

Strength of Marginal Dependences: Relational

Learning a relational network consists in finding those subspace, for which the intersection of the cylindrical extensions of the projections to these subspaces approximates best the set of possible world states, i. e. contains as few additional tuples as possible.

Since computing explicitly the intersection of the cylindrical extensions of the projections and comparing it to the original relation is too expensive, local evaluation functions are used, for instance:

| subspace | color \times shape | shape \times size | size \times color |
|------------------------|----------------------|---------------------|---------------------|
| possible combinations | 12 | 9 | 12 |
| occurring combinations | 6 | 5 | 8 |
| relative number | 50% | 56% | 67% |

The relational network can be obtained by interpreting the relative numbers as edge weights and constructing the minimum weight spanning tree.

Strength of Marginal Dependences: Relational

| | | | |
|---|---|---|---|
| | ■ | | ■ |
| | | ■ | ■ |
| ■ | ■ | | |

Hartley information needed to determine

coordinates: $\log_2 4 + \log_2 3 = \log_2 12 \approx 3.58$

coordinate pair: $\log_2 6 \approx 2.58$

gain: $\log_2 12 - \log_2 6 = \log_2 2 = 1$

Definition: Let A and B be two attributes and R a discrete possibility measure with $\exists a \in \text{dom}(A) : \exists b \in \text{dom}(B) : R(A = a, B = b) = 1$. Then

$$\begin{aligned} I_{\text{gain}}^{(\text{Hartley})}(A, B) &= \log_2 \left(\sum_{a \in \text{dom}(A)} R(A = a) \right) + \log_2 \left(\sum_{b \in \text{dom}(B)} R(B = b) \right) \\ &\quad - \log_2 \left(\sum_{a \in \text{dom}(A)} \sum_{b \in \text{dom}(B)} R(A = a, B = b) \right) \\ &= \log_2 \frac{\left(\sum_{a \in \text{dom}(A)} R(A = a) \right) \cdot \left(\sum_{b \in \text{dom}(B)} R(B = b) \right)}{\sum_{a \in \text{dom}(A)} \sum_{b \in \text{dom}(B)} R(A = a, B = b)}, \end{aligned}$$

is called the **Hartley information gain** of A and B w.r.t. R .

Strength of Marginal Dependences: Simple Example

Intuitive interpretation of Hartley information gain:

The binary logarithm measures the number of questions to find the obtaining value with a scheme like a binary search. Thus Hartley information gain measures the reduction in the number of necessary questions.

Results for the simple example:

$$I_{\text{gain}}^{(\text{Hartley})}(\text{color, shape}) = 1.00 \text{ bit}$$

$$I_{\text{gain}}^{(\text{Hartley})}(\text{shape, size}) \approx 0.86 \text{ bit}$$

$$I_{\text{gain}}^{(\text{Hartley})}(\text{color, size}) \approx 0.58 \text{ bit}$$

Applying the Kruskal algorithm yields as a learning result:

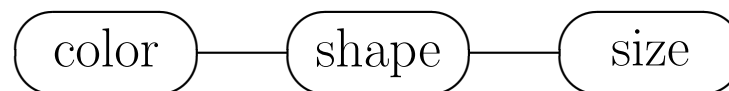

As we know, this graph describes indeed a decomposition of the relation.

Strength of Marginal Dependences: Probabilistic

Mutual Information / Cross Entropy / Information Gain

Based on Shannon Entropy $H = - \sum_{i=1}^n p_i \log_2 p_i$ (Shannon 1948)

$$\begin{aligned} I_{\text{gain}}(A, B) &= \underbrace{H(A)}_{-\sum_a P(a) \log_2 P(a)} - \underbrace{H(A | B)}_{\sum_b P(b) \left(-\sum_a P(a|b) \log_2 P(a|b) \right)} \\ &= -\sum_a P(a) \log_2 P(a) - \sum_b P(b) \left(-\sum_a P(a|b) \log_2 P(a|b) \right) \end{aligned}$$

$H(A)$ Entropy of the distribution on attribute A
 $H(A|B)$ *Expected entropy* of the distribution on attribute A
if the value of attribute B becomes known
 $H(A) - H(A|B)$ Expected reduction in entropy or *information gain*

Strength of Marginal Dependences: Probabilistic

$$\begin{aligned} I_{\text{gain}}(A, B) &= - \sum_a P(a) \log_2 P(a) - \sum_b P(b) \left(- \sum_a P(a|b) \log_2 P(a|b) \right) \\ &= - \sum_a \sum_b P(a, b) \log_2 P(a) + \sum_b \sum_a P(a|b) P(b) \log_2 P(a|b) \\ &= \sum_a \sum_b P(a, b) \left(\log_2 \frac{P(a, b)}{P(b)} - \log_2 P(a) \right) \\ &= \sum_a \sum_b P(a, b) \log_2 \frac{P(a, b)}{P(a)P(b)} \end{aligned}$$







The information gain equals the Kullback-Leibler information divergence between the actual distribution $P(A, B)$ and a hypothetical distribution P^* in which A and B are marginal independent:

$$P^*(A, B) = P(A) \cdot P(B)$$







$$I_{\text{gain}}(A, B) = I_{\text{KLdiv}}(P, P^*)$$

Information Gain: Simple Example

projection to subspace



| |  |  |  |  |
|---|---|---|---|---|
|  | 40 | 180 | 20 | 160 |
|  | 12 | 6 | 120 | 102 |
|  | 168 | 144 | 30 | 18 |



product of marginals

| |  |  |  |  |
|--|---|---|---|---|
|  | 88 | 132 | 68 | 112 |
|  | 53 | 79 | 41 | 67 |
|  | 79 | 119 | 61 | 101 |





information gain





0.429 bit

| | s | m | l |
|---|-----|-----|-----|
|  | 20 | 180 | 200 |
|  | 40 | 160 | 40 |
|  | 180 | 120 | 60 |

| | s | m | l |
|--|----|-----|-----|
|  | 96 | 184 | 120 |
|  | 58 | 110 | 72 |
|  | 86 | 166 | 108 |

0.211 bit

| |  |  |  |  |
|--------|---|---|---|---|
| large | 50 | 115 | 35 | 100 |
| medium | 82 | 133 | 99 | 146 |
| small | 88 | 82 | 36 | 34 |

| |  |  |  |  |
|--------|---|---|---|---|
| large | 66 | 99 | 51 | 84 |
| medium | 101 | 152 | 78 | 129 |
| small | 53 | 79 | 41 | 67 |

0.050 bit

Strength of Marginal Dependences: Simple Example

Results for the simple example:

$$I_{\text{gain}}(\text{color}, \text{shape}) = 0.429 \text{ bit}$$

$$I_{\text{gain}}(\text{shape}, \text{size}) = 0.211 \text{ bit}$$

$$I_{\text{gain}}(\text{color}, \text{size}) = 0.050 \text{ bit}$$

The Kruskal algorithm is a greedy algorithm which can be used to determine the minimal spanning tree of an undirected graph.

Applying the Kruskal algorithm yields as a learning result:

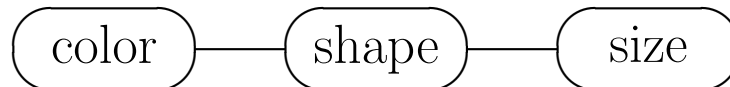

It can be shown that this approach always yields the best possible spanning tree w.r.t. Kullback-Leibler information divergence (Chow and Liu 1968).

In an extended form this also holds for certain classes of graphs (for example, tree-augmented naive Bayes classifiers).

For more complex graphs, the best graph need not be found (there are counterexamples, see below).

Optimum Weight Spanning Tree Construction

- Compute an evaluation measure on all possible edges (two-dimensional subspaces).
- Use the Kruskal algorithm to determine an optimum weight spanning tree.

Greedy Parent Selection (for directed graphs)

- Define a topological order of the attributes (to restrict the search space).
- Compute an evaluation measure on all single attribute hyperedges.
- For each preceding attribute (w.r.t. the topological order):
add it as a candidate parent to the hyperedge and
compute the evaluation measure again.
- Greedily select a parent according to the evaluation measure.
- Repeat the previous two steps until no improvement results from them.

K2 Algorithm

Idea: Compute the probability of a directed graph B_S given the database D (Bayesian approach by [Cooper and Herskovits 1992])

$$\begin{aligned}\hat{B}_S &= \arg \max_{B_S} P(B_S | D) = \arg \max_{B_S} \frac{P(B_S, D)}{P(D)} \\ &= \arg \max_{B_S} P(B_S, D)\end{aligned}$$

Find an equation for $P(B_S, D)$.

Model Averaging

We first consider $P(B_S, D)$ to be the marginalization of $P(B_S, B_P, D)$ over all possible parameters B_P .

$$\begin{aligned} P(B_S, D) &= \int_{B_P} P(B_S, B_P, D) \, dB_P \\ &= \int_{B_P} P(D \mid B_S, B_P) P(B_S, B_P) \, dB_P \\ &= \int_{B_P} P(D \mid B_S, B_P) f(B_P \mid B_S) P(B_S) \, dB_P \\ &= \underbrace{P(B_S)}_{\text{A priori prob.}} \int_{B_P} \underbrace{P(D \mid B_S, B_P)}_{\text{Likelihood of } D} \underbrace{f(B_P \mid B_S)}_{\text{Parameter densities}} \, dB_P \end{aligned}$$

K2 Algorithm

The a priori distribution $P(B_S)$ can be used to bias the evaluation measure towards user-specific network structures.

Substitute the likelihood $P(D | B_S, B_P)$ for its specific form:

$$P(B_S, D) = P(B_S) \int_{B_P} \underbrace{\left[\prod_{i=1}^n \prod_{j=1}^{q_i} \prod_{k=1}^{r_i} \theta_{ijk}^{\alpha_{ijk}} \right]}_{P(D|B_S, B_P)} f(B_P | B_S) dB_P$$

See slide 355 for the derivation of the likelihood term.

K2 Algorithm

The parameter densities $f(B_P | B_S)$ describe the probabilities of the parameters given a network structure.

They are densities of second order (distribution over distributions)

For fixed i and j , a vector $(\theta_{ij1}, \dots, \theta_{ijr_i})$ represents a probability distribution, namely the j -th column of the i -th potential table.

Assuming mutual independence between the potential tables, we arrive for $f(B_P | B_S)$ at the following:

$$f(B_P | B_S) = \prod_{i=1}^n \prod_{j=1}^{q_i} f(\theta_{ij1}, \dots, \theta_{ijr_i})$$

K2 Algorithm

Thus, we can further concretize the equation for $P(B_S, D)$:

$$\begin{aligned} P(B_S, D) &= P(B_S) \int \cdots \int_{\theta_{ijk}} \left[\prod_{i=1}^n \prod_{j=1}^{q_i} \prod_{k=1}^{r_i} \theta_{ijk}^{\alpha_{ijk}} \right] \cdot \left[\prod_{i=1}^n \prod_{j=1}^{q_i} f(\theta_{ij1}, \dots, \theta_{ijr_i}) \right] d\theta_{111}, \dots, d\theta_{nq_n r_n} \\ &= P(B_S) \prod_{i=1}^n \prod_{j=1}^{q_i} \int \cdots \int_{\theta_{ijk}} \left[\prod_{k=1}^{r_i} \theta_{ijk}^{\alpha_{ijk}} \right] \cdot f(\theta_{ij1}, \dots, \theta_{ijr_i}) d\theta_{ij1}, \dots, d\theta_{ijr_i} \end{aligned}$$

K2 Algorithm

A last assumption: For fixed i and j the density $f(\theta_{ij1}, \dots, \theta_{ijr_i})$ is uniform:

$$f(\theta_{ij1}, \dots, \theta_{ijr_i}) = (r_i - 1)!$$

It simplifies $P(B_S, D)$ further:

$$\begin{aligned} P(B_S, D) &= P(B_S) \prod_{i=1}^n \prod_{j=1}^{q_i} \int \cdots \int_{\theta_{ijk}} \left[\prod_{k=1}^{r_i} \theta_{ijk}^{\alpha_{ijk}} \right] \cdot (r_i - 1)! d\theta_{ij1}, \dots, d\theta_{ijr_i} \\ &= P(B_S) \prod_{i=1}^n \prod_{j=1}^{q_i} (r_i - 1)! \underbrace{\int \cdots \int_{\theta_{ijk}} \prod_{k=1}^{r_i} \theta_{ijk}^{\alpha_{ijk}} d\theta_{ij1}, \dots, d\theta_{ijr_i}}_{\text{Dirichlet's integral}} \\ &\quad \text{Dirichlet's integral} = \frac{\prod_{k=1}^{r_i} \alpha_{ijk}!}{(\sum_{k=1}^{r_i} \alpha_{ijk} + r_i - 1)!} \end{aligned}$$

K2 Algorithm

We finally arrive at an expression for $P(B_S, D)$:

$$P(B_S, D) = \text{K2}(B_S | D) = P(B_S) \prod_{i=1}^n \prod_{j=1}^{q_i} \left[\frac{(r_i - 1)!}{(N_{ij} + r_i - 1)!} \prod_{k=1}^{r_i} \alpha_{ijk}! \right]$$

n number of attributes describing the domain under consideration

r_i number of values of the i -th attribute A_i , i. e., $r_i = |\text{dom}(A_i)|$

q_i number of instantiations of the parents of the i -th attribute in \vec{G} ,
i. e., $q_i = \prod_{A_j \in \text{parents}(A_i)} r_j = \prod_{A_j \in \text{parents}(A_i)} |\text{dom}(A_j)|$

α_{ijk} number of sample cases in which the i -th attribute has its k -th value
and its parents in \vec{G} have their j -th instantiation

$$N_{ij} = \sum_{k=1}^{r_i} \alpha_{ijk}$$

Properties of the K2 Metric

Global — Refers to the outer product: The total value of the K2 metric is the product over all K2 values of attribute families.

Local — The likelihood equation assumes that given a parents instantiation, the probabilities for the respective child attribute values are mutual independent. This is reflected in the product over all q_i different parent attributes' value combinations of attribute A_i .

We exploit the global property to write the K2 metric as follows:

$$\text{K2}(B_S | D) = P(B_S) \prod_{i=1}^n \text{K2}_{\text{local}}(A_i | D)$$

with

$$\text{K2}_{\text{local}}(A_i | D) = \prod_{j=1}^{q_i} \left[\frac{(r_i - 1)!}{(N_{ij} + r_i - 1)!} \prod_{k=1}^{r_i} \alpha_{ijk}! \right]$$

K2 Algorithm

Prerequisites:

Choose a topological order on the attributes (A_1, \dots, A_n)

Start out with a network that consists of n isolated nodes.

Let ζ_i be the quality of the i -th attribute given the (tentative) set of parent attributes M :

$$\zeta_i(M) = \text{K2}_{\text{local}}(A_i \mid D) \quad \text{with} \quad \text{parents}(A_i) = M$$

K2 Algorithm

Execution:

1. Determine for the parentless node A_i the quality measure $\zeta_i(\emptyset)$
2. Evaluate for every predecessor $\{A_1, \dots, A_{i-1}\}$ whether inserted as parent of A_i , the quality measure would increase. Let Y be the node that yields the highest quality (increase):

$$Y = \arg \max_{1 \leq l \leq i-1} \zeta_i(\{A_l\})$$

This best quality measure be $\zeta = \zeta_i(\{Y\})$.

3. If ζ is better than $\zeta_i(\emptyset)$, Y is inserted permanently as a parent node: $\text{parents}(A_i) = \text{parents}(A_i) \cup \{Y\}$
4. Repeat steps 2 and 3 to increase the parent set until no quality increase can be achieved or no nodes are left or a predefined maximum number of parent nodes per node is reached.

K2 Algorithm

```
1: for  $i \leftarrow 1 \dots n$  do // Initialization
2:    $\text{parents}(A_i) \leftarrow \emptyset$ 
3: end for
4: for  $i \leftarrow n, \dots, 1$  do // Iteration
5:   repeat
6:     Select  $Y \in \{A_1, \dots, A_{i-1}\} \setminus \text{parents}(A_i)$ ,
       which maximizes  $\zeta = \zeta_i(\text{parents}(A_i) \cup \{Y\})$ 
7:      $\delta \leftarrow \zeta - \zeta_i(\text{parents}(A_i))$ 
8:     if  $\delta > 0$  then
9:        $\text{parents}(A_i) \leftarrow \text{parents}(A_i) \cup \{Y\}$ 
10:    end if
11:   until  $\delta \leq 0$  or  $\text{parents}(A_i) = \{A_1, \dots, A_{i-1}\}$  or  $|\text{parents}(A_i)| = n_{\max}$ 
12: end for
```

Demo of K2 Algorithm

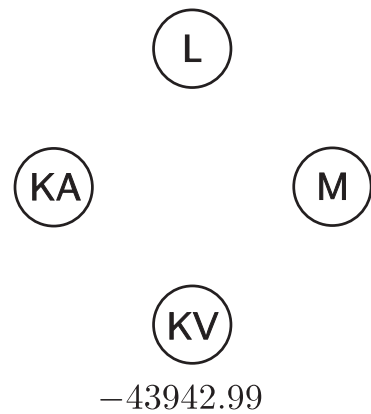

Step 1 – Edgeless graph

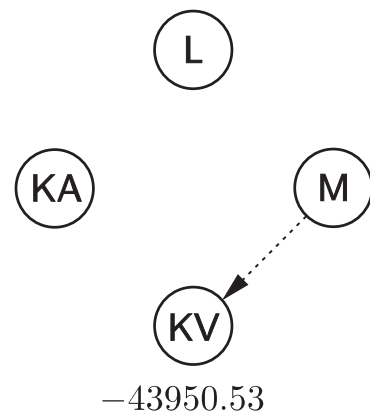

Step 2 – Insert M temporarily.

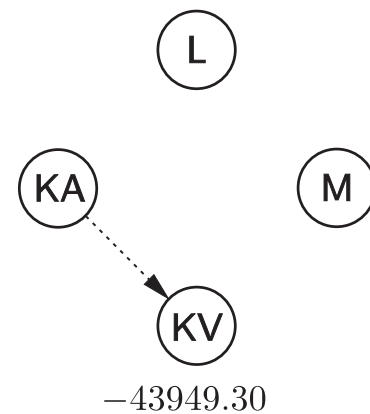

Step 3 – Insert KA temporarily.

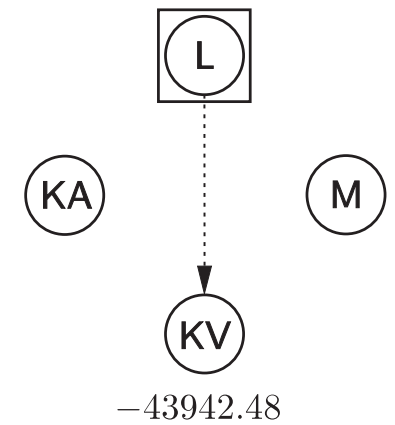

Step 4 – Node L maximizes K2 value and thus is added permanently.

Demo of K2 Algorithm

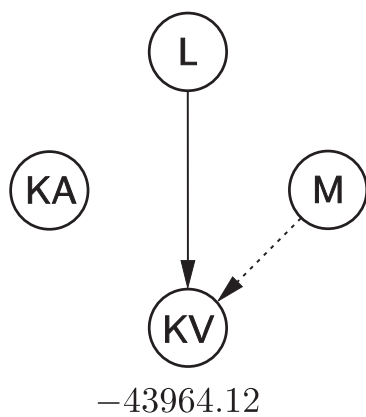

Step 5 – Insert **M** temporarily.

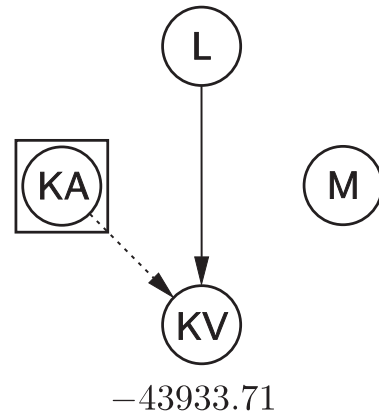

Step 6 – **KA** is added as second parent node of **KV**.

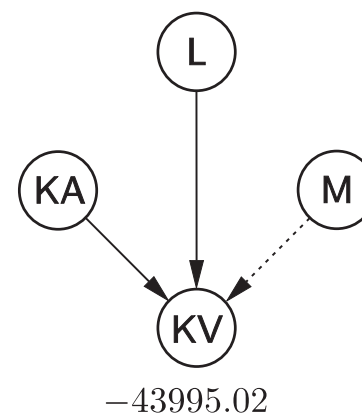

Step 7 – **M** does not increase the quality of the network if inserts as third parent node.

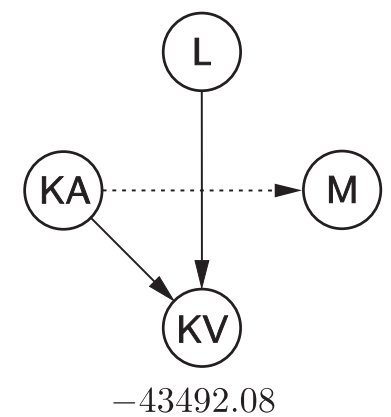

Step 8 – Insert **KA** temporarily.

Demo of K2 Algorithm

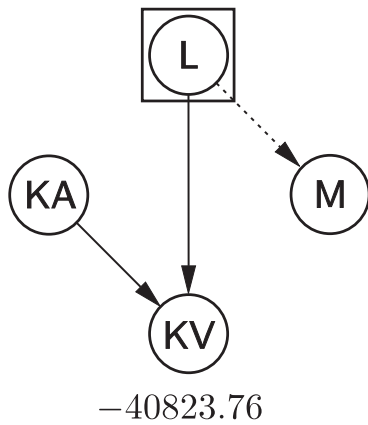

Step 9 – Node **L** becomes parent node of **M**.

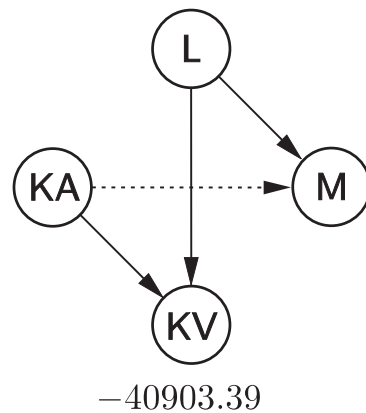

Step 10 – Adding **KA** does not increase overall network quality.

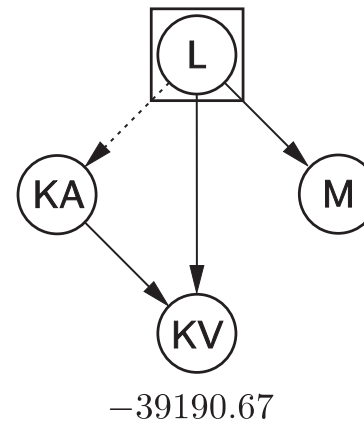

Step 11 – Node **L** becomes parent node of **KA**.

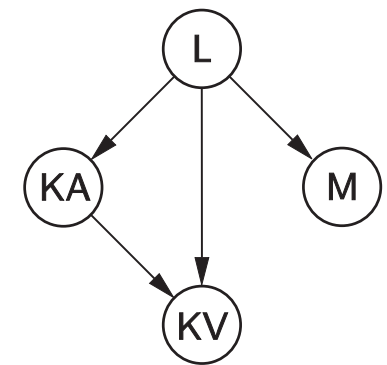

Result

Strength of Marginal Dependences: Drawbacks

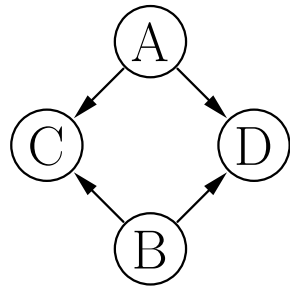

| p_A | a_1 | a_2 |
|-------|-------|-------|
| | 0.5 | 0.5 |

| p_B | b_1 | b_2 |
|-------|-------|-------|
| | 0.5 | 0.5 |

| $p_{C AB}$ | a_1b_1 | a_1b_2 | a_2b_1 | a_2b_2 |
|------------|----------|----------|----------|----------|
| c_1 | 0.9 | 0.3 | 0.3 | 0.5 |
| c_2 | 0.1 | 0.7 | 0.7 | 0.5 |

| $p_{D AB}$ | a_1b_1 | a_1b_2 | a_2b_1 | a_2b_2 |
|------------|----------|----------|----------|----------|
| d_1 | 0.9 | 0.3 | 0.3 | 0.5 |
| d_2 | 0.1 | 0.7 | 0.7 | 0.5 |

| p_{AD} | a_1 | a_2 |
|----------|-------|-------|
| d_1 | 0.3 | 0.2 |
| d_2 | 0.2 | 0.3 |

| p_{BD} | b_1 | b_2 |
|----------|-------|-------|
| d_1 | 0.3 | 0.2 |
| d_2 | 0.2 | 0.3 |

| p_{CD} | c_1 | c_2 |
|----------|-------|-------|
| d_1 | 0.31 | 0.19 |
| d_2 | 0.19 | 0.31 |

Greedy parent selection can lead to suboptimal results if there is more than one path connecting two attributes.

Here: the edge $C \rightarrow D$ is selected first.

Learning the Structure of Graphical Models from Data

(A) Test whether a distribution is decomposable w.r.t. a given graph.

This is the most direct approach. It is not bound to a graphical representation, but can also be carried out w.r.t. other representations of the set of subspaces to be used to compute the (candidate) decomposition of the given distribution.

(B) Find a suitable graph by measuring the strength of dependences.

This is a heuristic, but often highly successful approach, which is based on the frequently valid assumption that in a conditional independence graph an attribute is more strongly dependent on adjacent attributes than on attributes that are not directly connected to them.

(C) Find an independence map by conditional independence tests.

This approach exploits the theorems that connect conditional independence graphs and graphs that represent decompositions. It has the advantage that a single conditional independence test, if it fails, can exclude several candidate graphs. However, wrong test results can thus have severe consequences.

Structure Learning with Conditional Independence Tests

General Idea: Exploit the theorems that connect conditional independence graphs and graphs that represent decompositions.

In other words: we want a graph describing a decomposition,
but we search for a conditional independence graph.

This approach has the advantage that a single conditional independence test, if it fails, can exclude several candidate graphs.

Assumptions:

Faithfulness: The domain under consideration can be accurately described with a graphical model (more precisely: there exists a perfect map).

Reliability of Tests: The result of all conditional independence tests coincides with the actual situation in the underlying distribution.

Other assumptions that are specific to individual algorithms.

Conditional Independence Tests: Relational

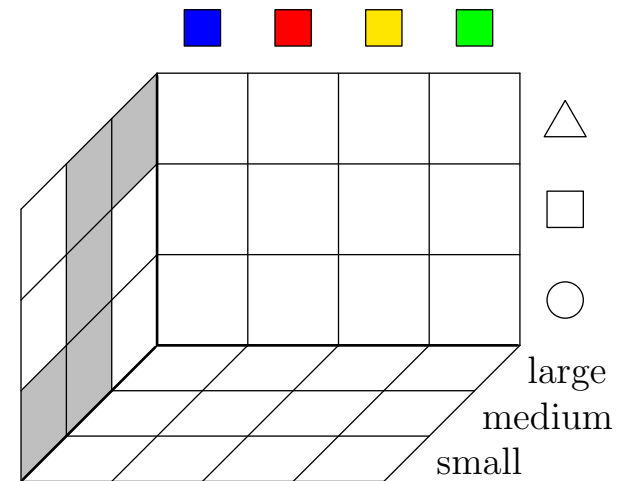
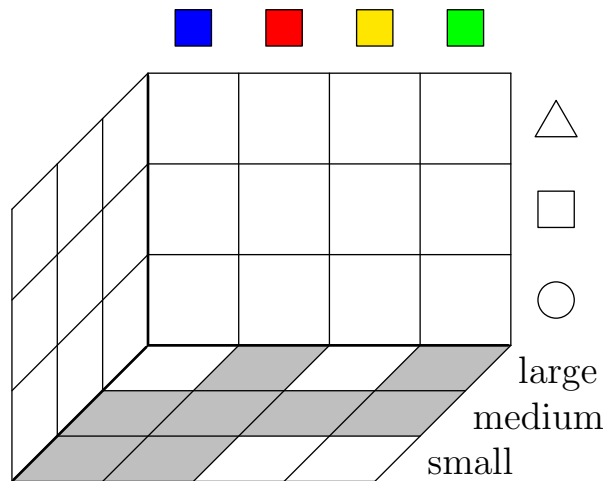
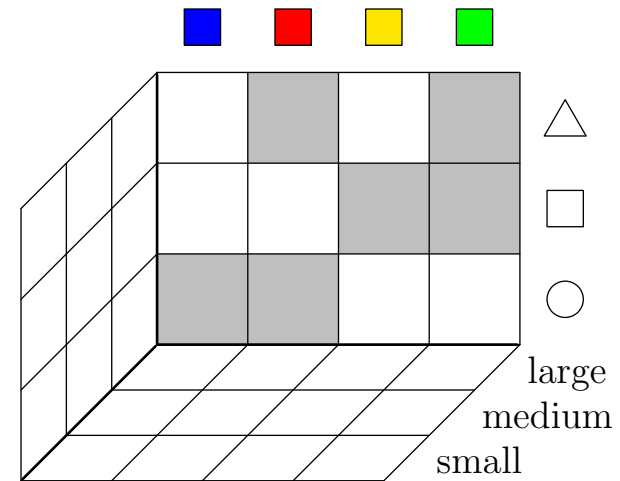
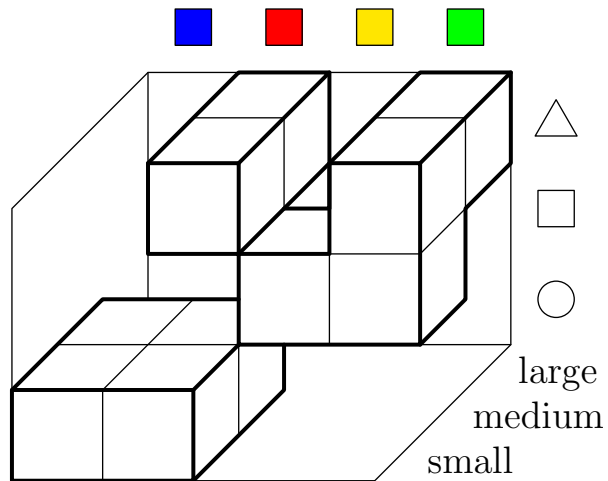

Conditional Independence Tests: Relational

The Hartley information gain can be used directly to test for (approximate) **marginal independence**.

| attributes | relative number of possible value combinations | Hartley information gain |
|--------------|--|---|
| color, shape | $\frac{6}{3 \cdot 4} = \frac{1}{2} = 50\%$ | $\log_2 3 + \log_2 4 - \log_2 6 = 1$ |
| color, size | $\frac{8}{3 \cdot 4} = \frac{2}{3} \approx 67\%$ | $\log_2 3 + \log_2 4 - \log_2 8 \approx 0.58$ |
| shape, size | $\frac{5}{3 \cdot 3} = \frac{5}{9} \approx 56\%$ | $\log_2 3 + \log_2 3 - \log_2 5 \approx 0.85$ |

In order to test for (approximate) **conditional independence**:

- Compute the Hartley information gain for each possible instantiation of the conditioning attributes.
- Aggregate the result over all possible instantiations, for instance, by simply averaging them.

Conditional Independence Tests: Simple Example

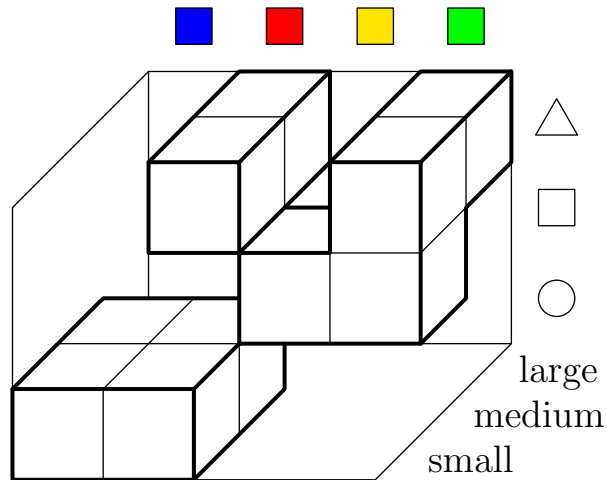

| color | Hartley information gain |
|---------------------------------------|---|
| ■ | $\log_2 1 + \log_2 2 - \log_2 2 = 0$ |
| ■ | $\log_2 2 + \log_2 3 - \log_2 4 \approx 0.58$ |
| ■ | $\log_2 1 + \log_2 1 - \log_2 1 = 0$ |
| ■ | $\log_2 2 + \log_2 2 - \log_2 2 = 1$ |
| | average: ≈ 0.40 |

| shape | Hartley information gain |
|-------|--------------------------------------|
| △ | $\log_2 2 + \log_2 2 - \log_2 4 = 0$ |
| □ | $\log_2 2 + \log_2 1 - \log_2 2 = 0$ |
| ○ | $\log_2 2 + \log_2 2 - \log_2 4 = 0$ |
| | average: $= 0$ |

| size | Hartley information gain |
|--------|--------------------------------------|
| large | $\log_2 2 + \log_2 1 - \log_2 2 = 0$ |
| medium | $\log_2 4 + \log_2 3 - \log_2 6 = 1$ |
| small | $\log_2 2 + \log_2 1 - \log_2 2 = 0$ |
| | average: ≈ 0.33 |

Conditional Independence Tests: Simple Example

The Shannon information gain can be used directly to test for (approximate) **marginal independence**.

Conditional independence tests may be carried out by summing the information gain for all instantiations of the conditioning variables:

$$I_{\text{gain}}(A, B \mid C) = \sum_{c \in \text{dom}(C)} P(c) \sum_{a \in \text{dom}(A)} \sum_{b \in \text{dom}(B)} P(a, b \mid c) \log_2 \frac{P(a, b \mid c)}{P(a \mid c) P(b \mid c)},$$

where $P(c)$ is an abbreviation of $P(C = c)$ etc.

Since $I_{\text{gain}}(\text{color}, \text{size} \mid \text{shape}) = 0$ indicates the only conditional independence, we get the following learning result:



Conditional Independence Tests: General Algorithm

Algorithm: (conditional independence graph construction)

1. For each pair of attributes A and B , search for a set $S_{AB} \subseteq U \setminus \{A, B\}$ such that $A \perp\!\!\!\perp B \mid S_{AB}$ holds in \hat{P} , i.e., A and B are independent in \hat{P} conditioned on S_{AB} . If there is no such S_{AB} , connect the attributes by an undirected edge.
2. For each pair of non-adjacent variables A and B with a common neighbour C (i.e., C is adjacent to A as well as to B), check whether $C \in S_{AB}$.
 - If it is, continue.
 - If it is not, add arrow heads pointing to C , i.e., $A \rightarrow C \leftarrow B$.
3. Recursively direct all undirected edges according to the rules:
 - If for two adjacent variables A and B there is a strictly directed path from A to B not including $A \rightarrow B$, then direct the edge towards B .
 - If there are three variables A , B , and C with A and B not adjacent, $B - C$, and $A \rightarrow C$, then direct the edge $C \rightarrow B$.

Conditional Independence Tests: Simple Example

Suppose that the following conditional independence statements hold:

$$\begin{array}{ll} A \perp\!\!\!\perp_{\hat{P}} B \mid \emptyset & B \perp\!\!\!\perp_{\hat{P}} A \mid \emptyset \\ A \perp\!\!\!\perp_{\hat{P}} D \mid C & D \perp\!\!\!\perp_{\hat{P}} A \mid C \\ B \perp\!\!\!\perp_{\hat{P}} D \mid C & D \perp\!\!\!\perp_{\hat{P}} B \mid C \end{array}$$

All other possible conditional independence statements that can be formed with the attributes A , B , C , and D (with single attributes on the left) do not hold.

Step 1: Since there is no set rendering A and C , B and C and C and D independent, the edges $A - C$, $B - C$, and $C - D$ are inserted.

Step 2: Since C is a common neighbor of A and B and we have $A \perp\!\!\!\perp_{\hat{P}} B \mid \emptyset$, but $A \not\perp\!\!\!\perp_{\hat{P}} B \mid C$, the first two edges must be directed $A \rightarrow C \leftarrow B$.

Step 3: Since A and D are not adjacent, $C - D$ and $A \rightarrow C$, the edge $C - D$ must be directed $C \rightarrow D$.

(Otherwise step 2 would have already fixed the orientation $C \leftarrow D$.)

Conditional Independence Tests: Drawbacks

The conditional independence graph construction algorithm presupposes that there is a **perfect map**. If there is no perfect map, the result may be invalid.

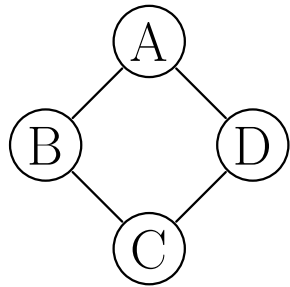

| p_{ABCD} | $A = a_1$ | | $A = a_2$ | | |
|------------|-----------|-----------|-----------|-----------|---------|
| | $B = b_1$ | $B = b_2$ | $B = b_1$ | $B = b_2$ | |
| $C = c_1$ | $D = d_1$ | $1/47$ | $1/47$ | $1/47$ | $2/47$ |
| | $D = d_2$ | $1/47$ | $1/47$ | $2/47$ | $4/47$ |
| $C = c_2$ | $D = d_1$ | $1/47$ | $2/47$ | $1/47$ | $4/47$ |
| | $D = d_2$ | $2/47$ | $4/47$ | $4/47$ | $16/47$ |

Independence tests of high order, i. e., with a large number of conditions, may be necessary.

There are approaches to mitigate these drawbacks.

(For example, the order is restricted and all tests of higher order are assumed to fail, if all tests of lower order failed.)

The Cheng–Bell–Liu Algorithm

Drafting: Build a so-called Chow–Liu tree as an initial graphical model.

- Evaluate all attribute pairs (candidate edges) with information gain.
- Discard edges with evaluation below independence threshold (~ 0.1 bits).
- Build optimum (maximum) weight spanning tree.

Thickening: Add necessary edges.

- Traverse remaining candidate edges in the order of decreasing evaluation.
- Test for conditional independence in order to determine whether an edge is needed in the graphical model.
- Use local Markov property to select a condition set: an attribute is conditionally independent of all non-descendants given its parents.
- Since the graph is undirected in this step, the set of adjacent nodes is reduced iteratively and greedily in order to remove possible children.

The Cheng–Bell–Liu Algorithm (continued)

Thinning: Remove superfluous edges.

- In the thickening phase a conditional independence test may have failed, because the graph was still too sparse.
- Traverse all edges that have been added to the current graphical model and test for conditional independence.
- Remove unnecessary edges.
(two phases/approaches: heuristic test/strict test)

Orienting: Direct the edges of the graphical model.

- Identify the v -structures (converging directed edges).
(Markov equivalence: same skeleton and same set of v -structures.)
- Traverse all pairs of attributes with common neighbors and check which common neighbors are in the (maximally) reduced set of conditions.
- Direct remaining edges by extending chains and avoiding cycles.

Learning Undirected Graphical Models Directly

Drafting: Build a Chow–Liu tree as an initial graphical model

- Evaluate all attribute pairs (candidate edges) with specificity gain.
- Discard edges with evaluation below independence threshold (~ 0.015).
- Build optimum (maximum) weight spanning tree.

Thickening: Add necessary edges.

- Traverse remaining candidate edges in the order of decreasing evaluation.
- Test for conditional independence in order to determine whether an edge is needed in the graphical model.
- Use local Markov property to select a condition set: an attribute is conditionally independent of any non-neighbor given its neighbors.
- Since the graphical model to be learned is undirected, *no (iterative) reduction of the condition set is needed* (decisive difference to Cheng–Bell–Liu Algorithm).

Learning Undirected Graphical Models Directly

Moralizing: Take care of possible v -structures.

- If one assumes a perfect undirected map, this step is unnecessary. However, v -structures are too common and cannot be represented without loss in an undirected graphical model.
- Possible v -structures can be taken care of by connecting the parents.
- Traverse all edges with an evaluation below the independence threshold that have a common neighbor in the graph.
- Add edge if conditional independence given the neighbors does not hold.

Thinning: Remove superfluous edges.

- In the thickening phase a conditional independence test may have failed, because the graph was still too sparse.
- Traverse all edges that have been added to the current graphical model and test for conditional independence.

Danish Jersey Cattle Blood Type Determination

| network | edges | params. | train | test |
|---------|-------|---------|----------|----------|
| indep. | 0 | 59 | -19921.2 | -20087.2 |
| orig. | 22 | 219 | -11391.0 | -11506.1 |

Optimum Weight Spanning Tree Construction

| measure | edges | params. | train | test |
|------------|-------|---------|----------|----------|
| I_{gain} | 20.0 | 285.9 | -12122.6 | -12339.6 |
| χ^2 | 20.0 | 282.9 | -12122.6 | -12336.2 |

Greedy Parent Selection w.r.t. a Topological Order

| measure | edges | add. | miss. | params. | train | test |
|-------------------|-------|------|-------|---------|----------|----------|
| I_{gain} | 35.0 | 17.1 | 4.1 | 1342.2 | -11229.3 | -11817.6 |
| χ^2 | 35.0 | 17.3 | 4.3 | 1300.8 | -11234.9 | -11805.2 |
| K2 | 23.3 | 1.4 | 0.1 | 229.9 | -11385.4 | -11511.5 |
| $L_{red}^{(rel)}$ | 22.5 | 0.6 | 0.1 | 219.9 | -11389.5 | -11508.2 |

Probabilistic Graphical Models: An Example

Danish Jersey Cattle Blood Type Determination

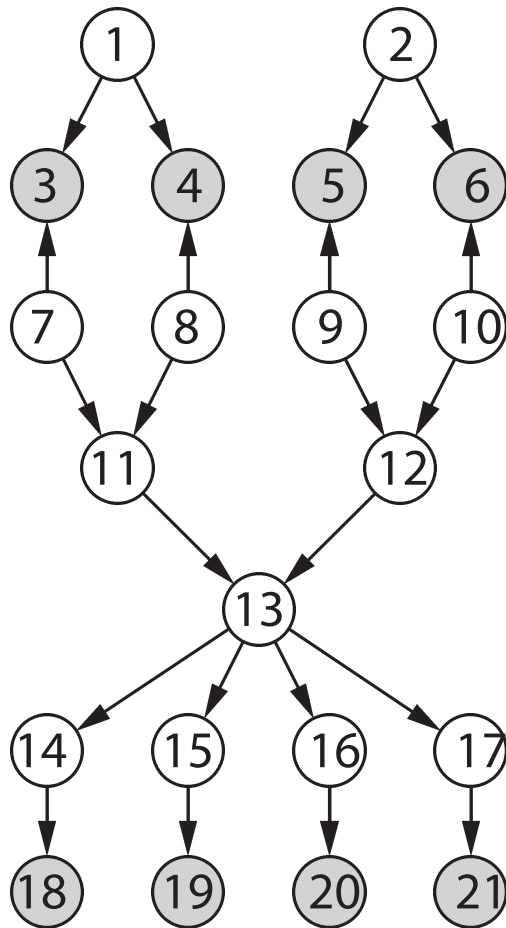

21 attributes:

- | | |
|--------------------------|-------------------------|
| 1 – dam correct? | 11 – offspring ph.gr. 1 |
| 2 – sire correct? | 12 – offspring ph.gr. 2 |
| 3 – stated dam ph.gr. 1 | 13 – offspring genotype |
| 4 – stated dam ph.gr. 2 | 14 – factor 40 |
| 5 – stated sire ph.gr. 1 | 15 – factor 41 |
| 6 – stated sire ph.gr. 2 | 16 – factor 42 |
| 7 – truedamph.gr. 1 | 17 – factor 43 |
| 8 – truedamph.gr. 2 | 18 – lysis40 |
| 9 – true sire ph.gr. 1 | 19 – lysis41 |
| 10 – true sire ph.gr. 2 | 20 – lysis 42 |
| | 21 – lysis 43 |

The grey nodes correspond to observable attributes.

Improving the Product Quality by Detecting Weaknesses

- Learn decision trees or inference network for vehicle properties and failures.
- Look for suspicious conditional failure rates.
- Find causes of these suspicious rates.
- Optimize design of vehicle.

Improve the Error Diagnosis in Service Garages

- Learn a decision tree or inference network for vehicle properties and failures.
- Record new faults.
- Test for most probable errors.

A Simple Approach to Fault Analysis

- Check subnets consisting of an attribute and its parent attributes.
- Select subnets with highest deviation from independent distribution.

Vehicle Properties

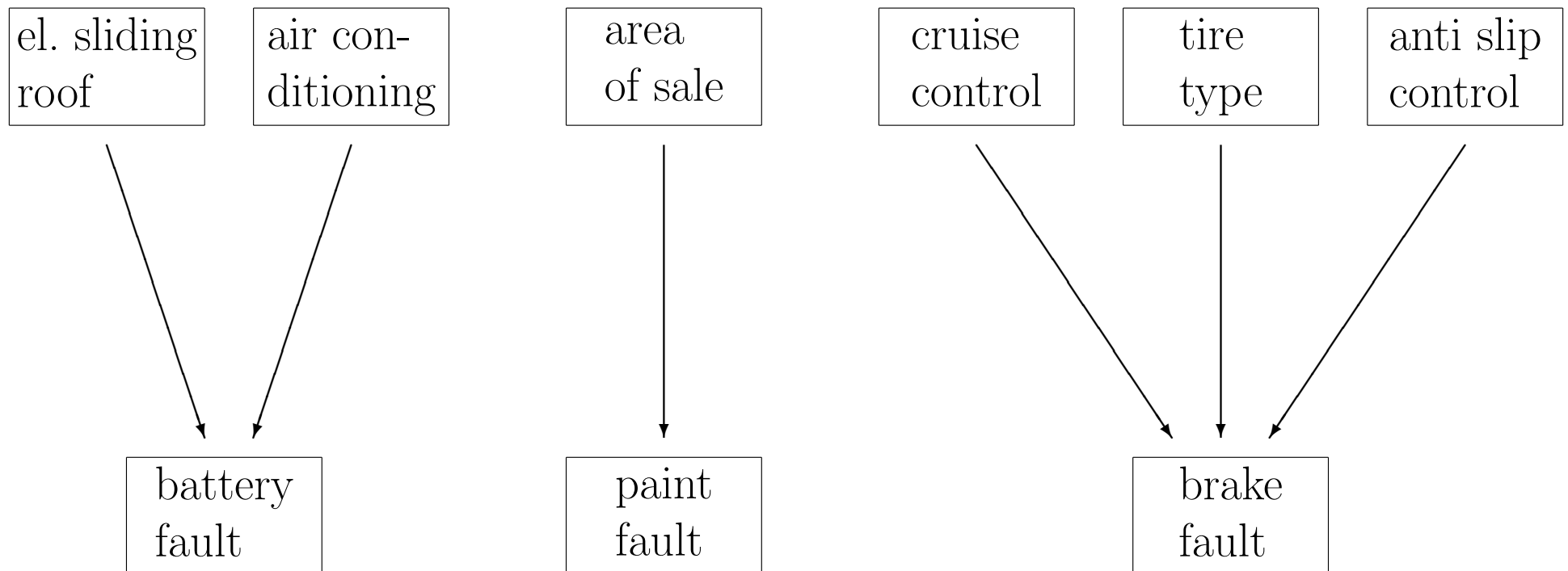

Fault Data

Example Subnet

Influence of special equipment on battery faults:

| (fictitious) frequency of battery faults | air conditioning | | |
|---|------------------|---------|-----|
| | with | without | |
| electrical sliding roof | with | 8 % | 3 % |
| | without | 3 % | 2 % |

- Significant deviation from independent distribution.
- Hints to possible causes and improvements.
- Here: Larger battery may be required, if an air conditioning system.
and an electrical sliding roof are built in.

(The dependencies and frequencies of this example are fictitious, true numbers are confidential.)